

EVOLVEO

deXy 2 Monitor stand

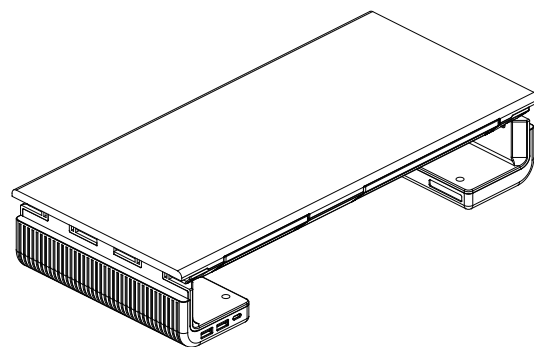

Package Includes

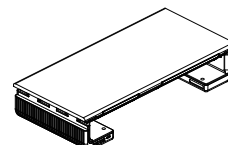

deXy 2 Product



USB 3.2 Gen 1 Cable

deXy 2 Product	1 PCS
USB 3.2 Gen 1 Cable	1 PCS
User Manual	1 PCS

EN

Features

- Sturdy structure supports loading up to 25kg
- Adjustable width for user's preference
- Smart space stores keyboard and mouse compactly
- Both-side flexible stands maximize space utility
- Built-in mobile phone / tablet stand
- Small size with PATENT design for shipping cost saving

Specifications

- Material: Plastic + Metal
- Product Size:
 - a. 420 x 200 x 80 mm
 - b. 470 x 200 x 80 mm
 - c. 520 x 200 x 80 mm

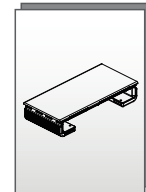

User Manual

Installation Guide

1. Take out the charging station from the box and verify the package contents.
2. Please open the stands and adjust it based on what you need. (total of four angles selection)



• Width adjustable stands Front View

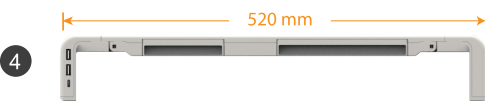
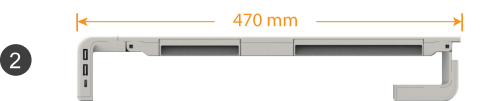

3. Please connect power adapter and USB cable with monitor stand firstly. Please connect USB cable with laptop, you can access external devices now.

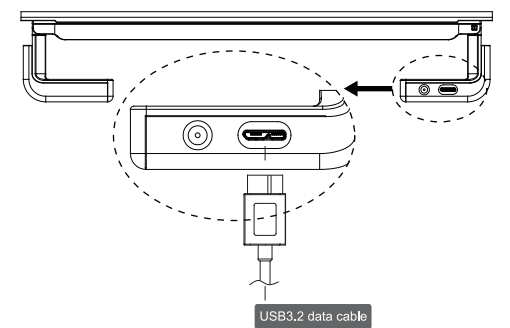
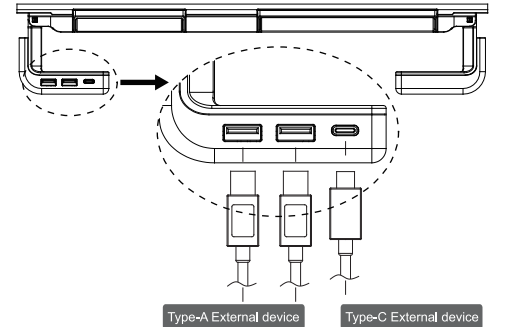

4. You can use the built-in mobile/tablet stands and store the stationery in smart drawer.
 - Built-in mobile phone/tablet stand and storage drawer

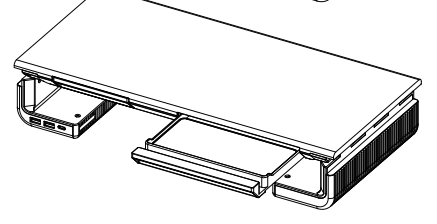
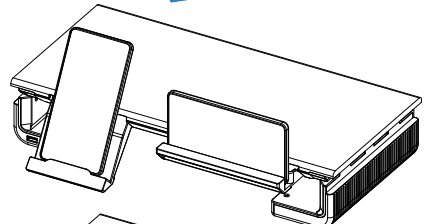
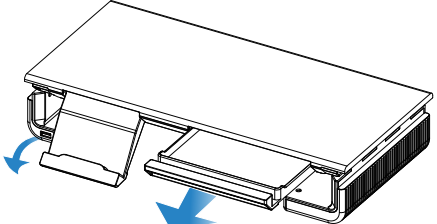

5. Put the monitor on this stand. You can enjoy using this product.



Disposal: The symbol of crossed out container on the product, in the literature or on the wrapping means that in the European Union all the electric and electronic products, batteries and accumulators must be placed into the separate salvage after finishing their lifetime. Do not throw these products into the unsorted municipal waste



DECLARATION OF CONFORMITY
Hereby, the company Abacus Electric, s.r.o. declares that the EVOLVEO deXy 2 is in compliance with the requirements of the standards and regulations, relevant for the given type of device.

Find the complete text of Declaration of Conformity at <ftp://ftp.evolveo.com/ce>

Dovozce / Dovožca / Importer / Importör
Abacus Electric, s.r.o.
Planá 2, 370 01, Czech Republic

Výrobce / Výrobca / Manufacturer / Gyártó
Naxya Limited
o.5, 17/F, Strand 50, 50 Bonham Strand, Sheung Wan, Hong Kong
Made in China

Copyright © Abacus Electric, s.r.o.
All rights reserved.
www.evolveo.com
Design and specification may be changed without prior notice.